

PONTE SUL FIUME MONTONE





PROVINCIA
DI RAVENNA

STATO DI FATTO

Il ponte esistente

INQUADRAMENTO TERRITORIALE



PROVINCIA
DI RAVENNA



PLANIMETRIA STATO DI FATTO



PROVINCIA
DI RAVENNA

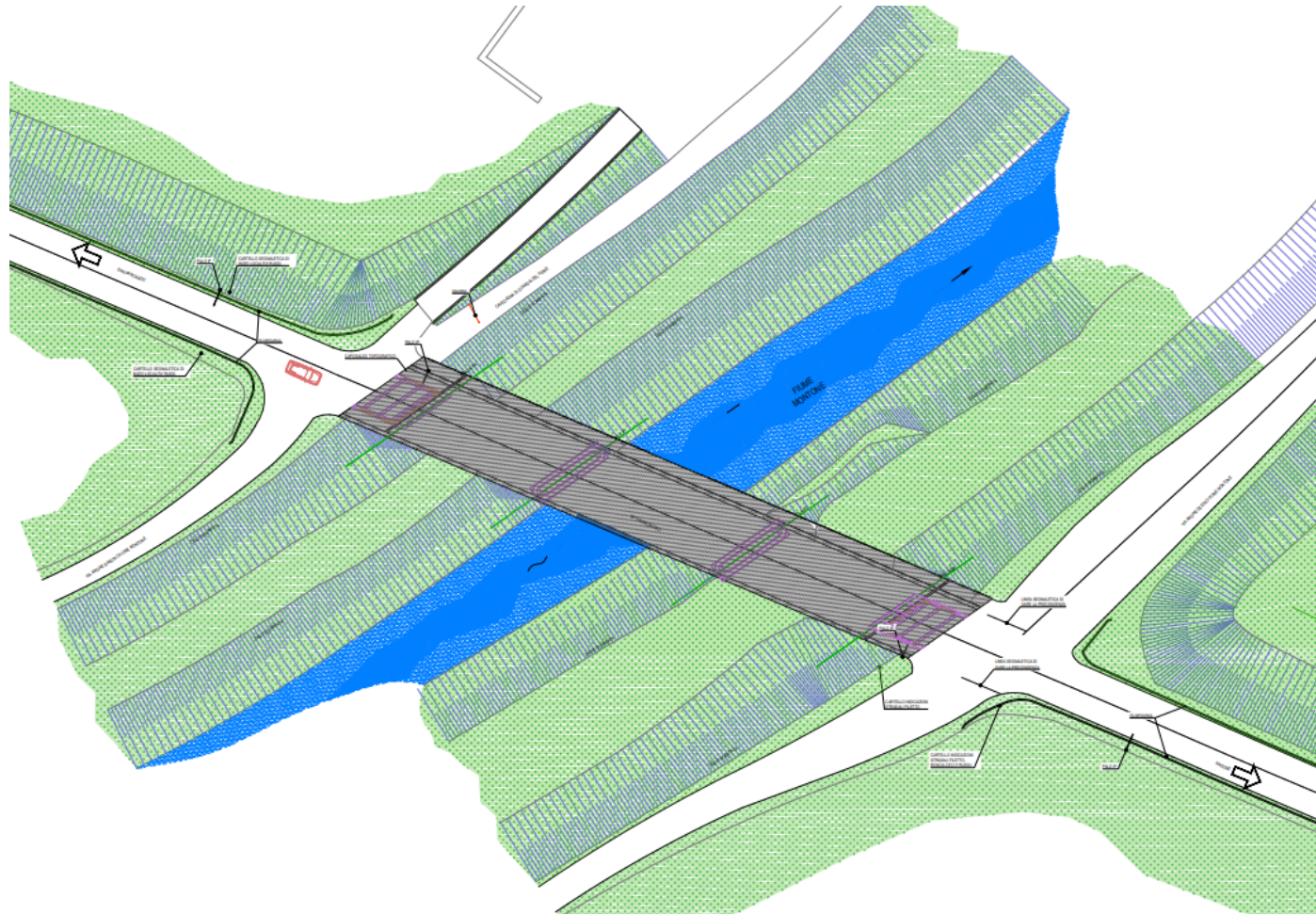

PROSPETTO E SEZIONE DEL PONTE ALLO STATO DI FATTO

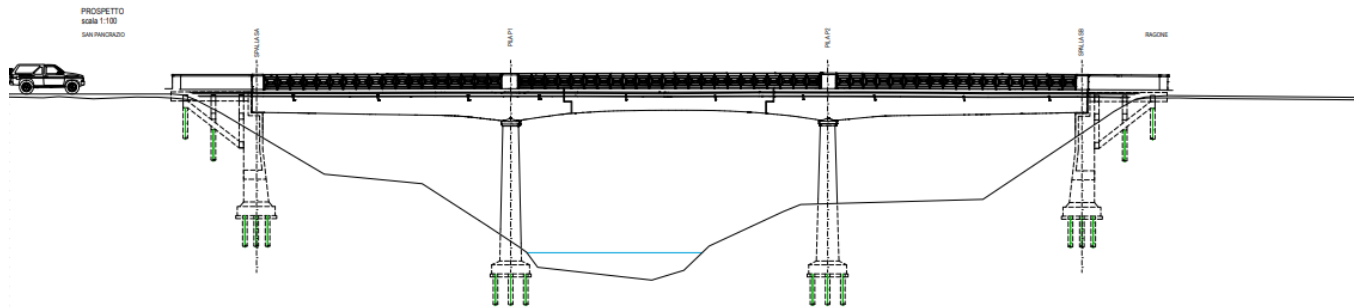

Ponte Stradale
(anni '30)

Lunghezza: 65,00m
Larghezza: 8,46m

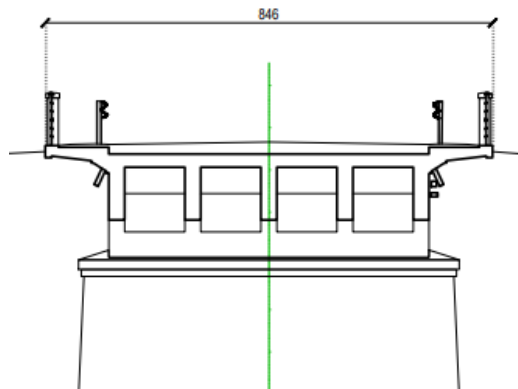



PROVINCIA
DI RAVENNA

STATO DI PROGETTO

Il nuovo ponte

TAVOLA COMPARATIVA

Prospetti laterali



PROVINCIA
DI RAVENNA

Stato di fatto

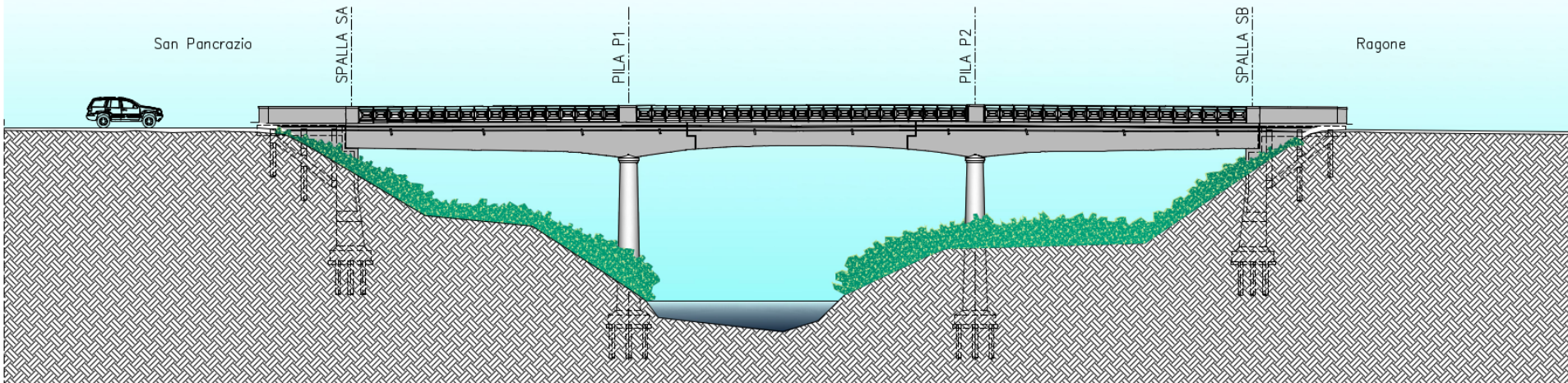

Stato di progetto



TAVOLA COMPARATIVA

Sezioni trasversali

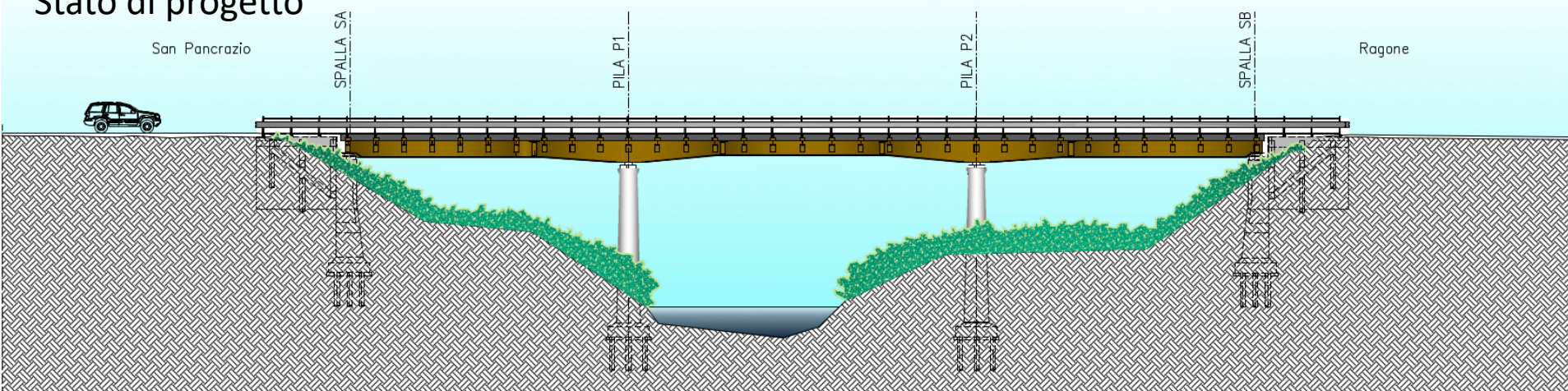

PROVINCIA
DI RAVENNA

Stato di fatto



Stato di progetto

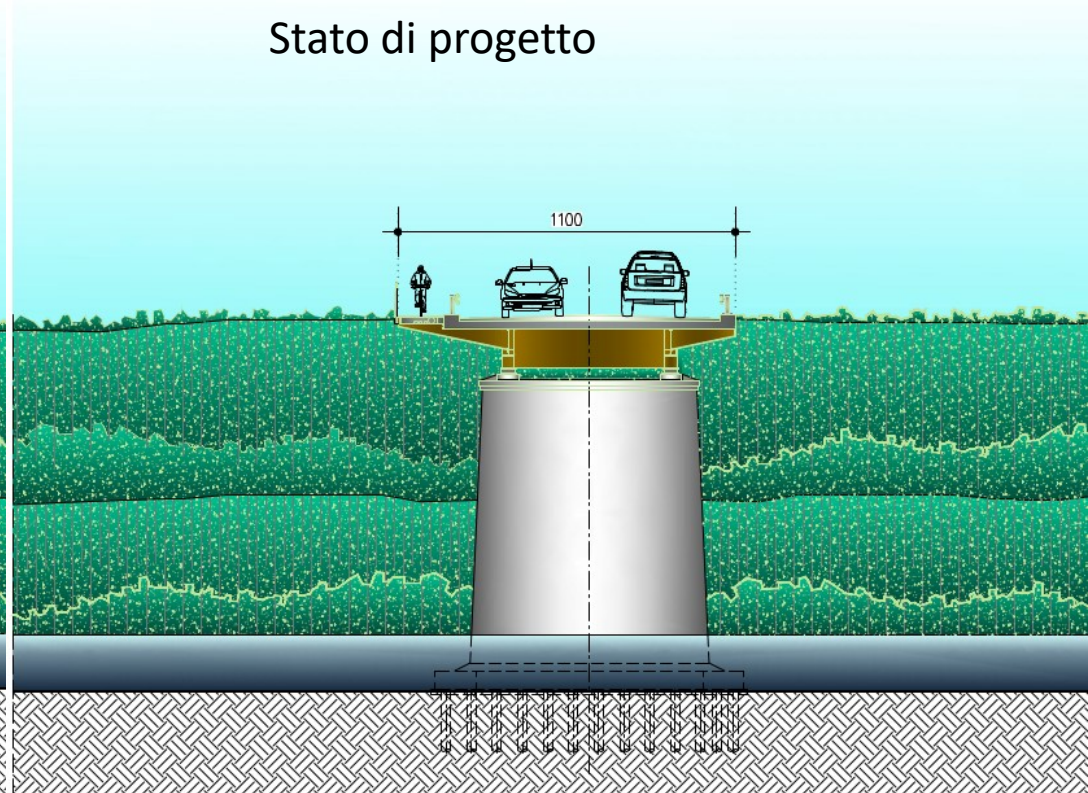



PROVINCIA
DI RAVENNA

PROSPETTO E SEZIONE DEL PONTE STATO DI PROGETTO

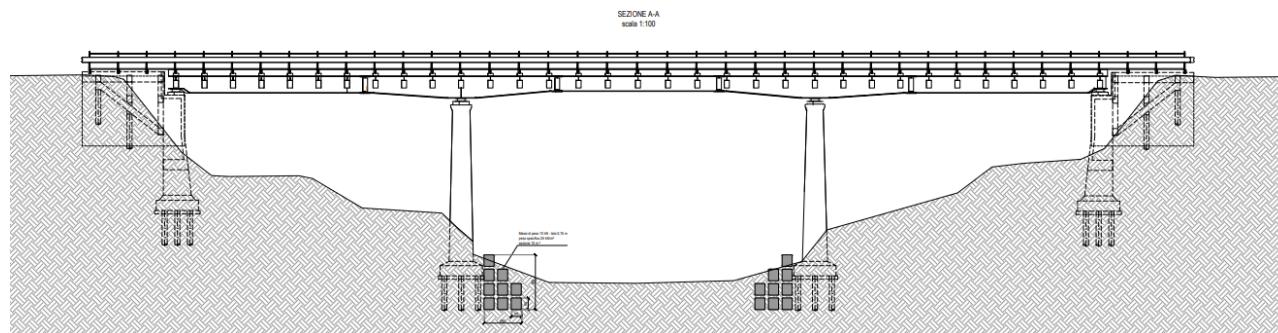

Ponte stradale con
Percorso protetto

Lunghezza: 65,00m

Larghezza: 11,00m

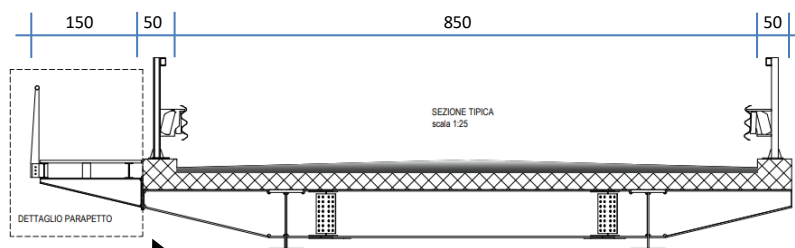

Percorso protetto

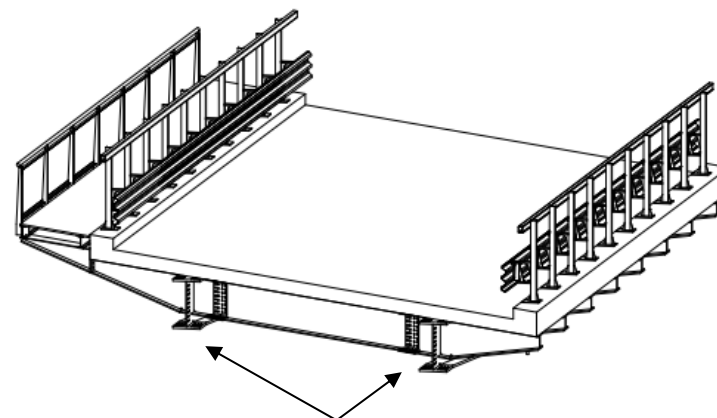

Travi metalliche principali

PROSPETTO E SEZIONE DEL PONTE CARPENTERIA STRUTTURA NUOVO IMPALCATO



PROVINCIA
DI RAVENNA

VISTA ASSONOMETRICA
scala 1:50
CONCIO DI MEZZERIA
Peso: 19.700 t

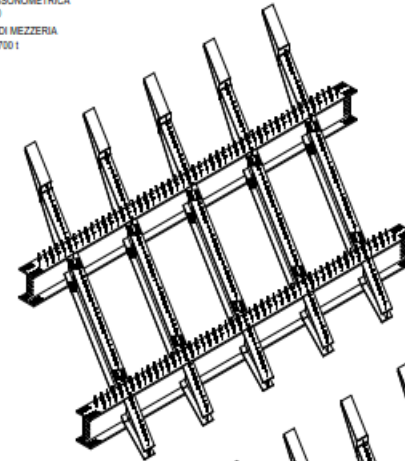

VISTA ASSONOMETRICA
scala 1:50
MACRO CONCIO
SPALLA SA - PILA P1
Peso: 59.211 t

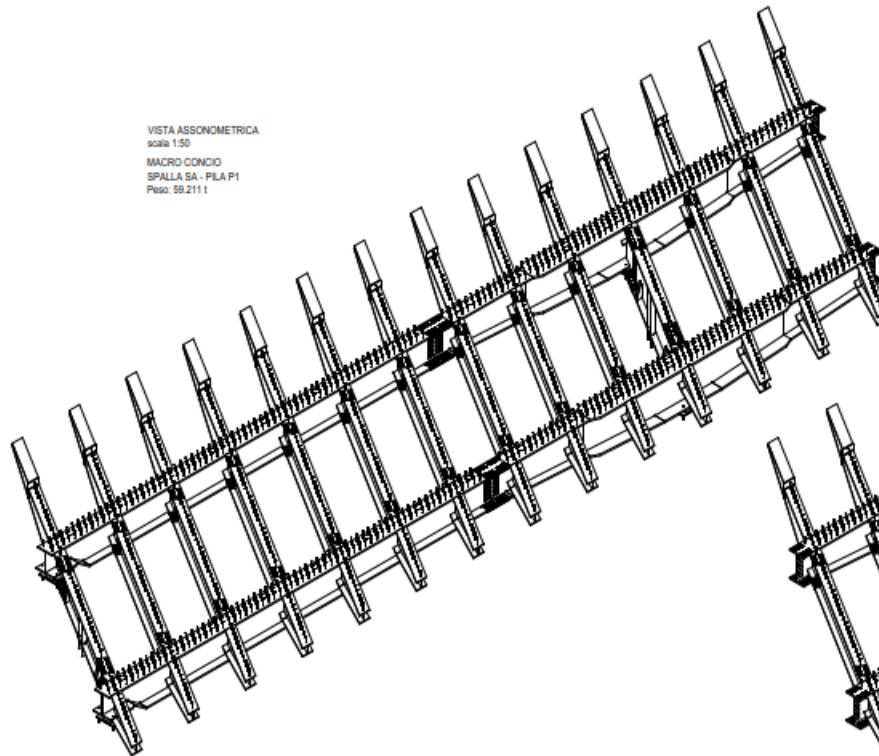

VISTA ASSONOMETRICA
scala 1:50
MACRO CONCIO
PILA P2 - SPALLA SB
Peso: 59.211 t

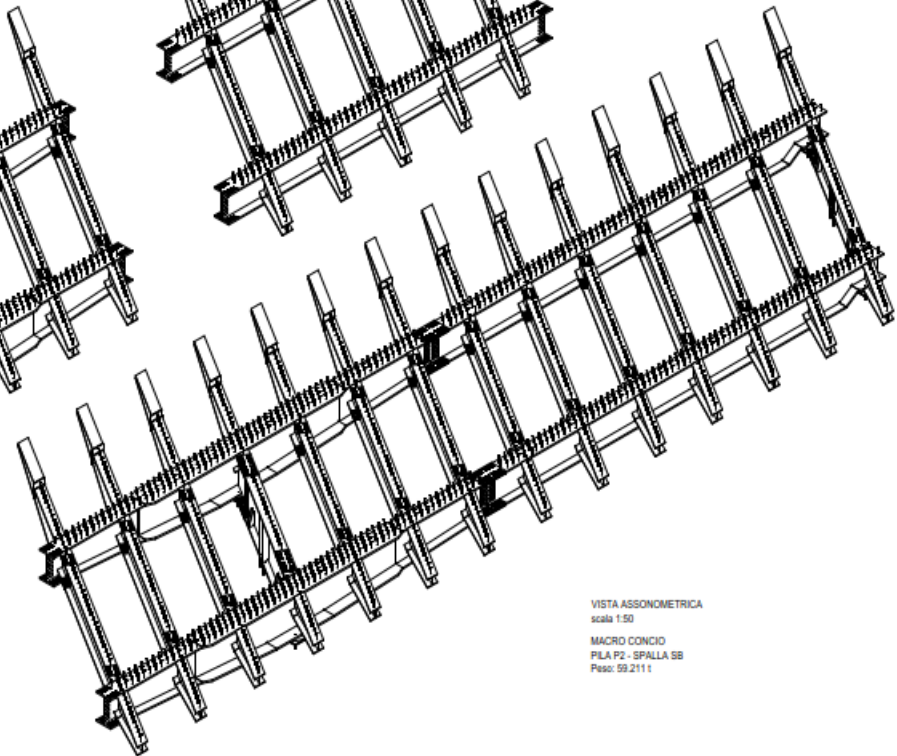

PROSPETTO E SEZIONE DEL PONTE

SEZIONI TRASVERSALI NUOVO IMPALCATO



PROVINCIA
DI RAVENNA

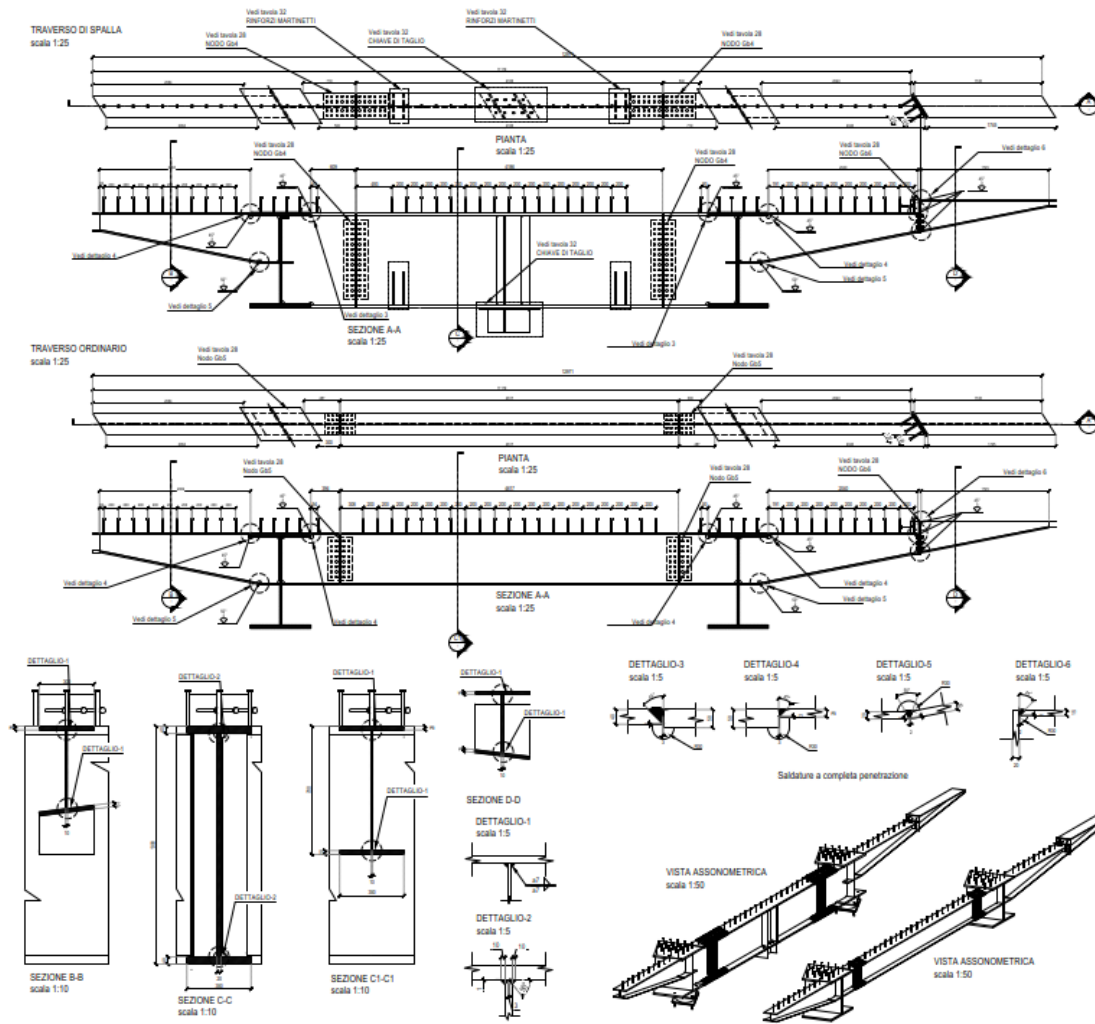



PROVINCIA
DI RAVENNA

MODELLO STRUTTURALE

Analisi FEM

della struttura e delle fasi realizzative



PROVINCIA
DI RAVENNA

MODELLO STRUTTURALE STATO DI PROGETTO

 SOFISTIK

 SOFISTIK

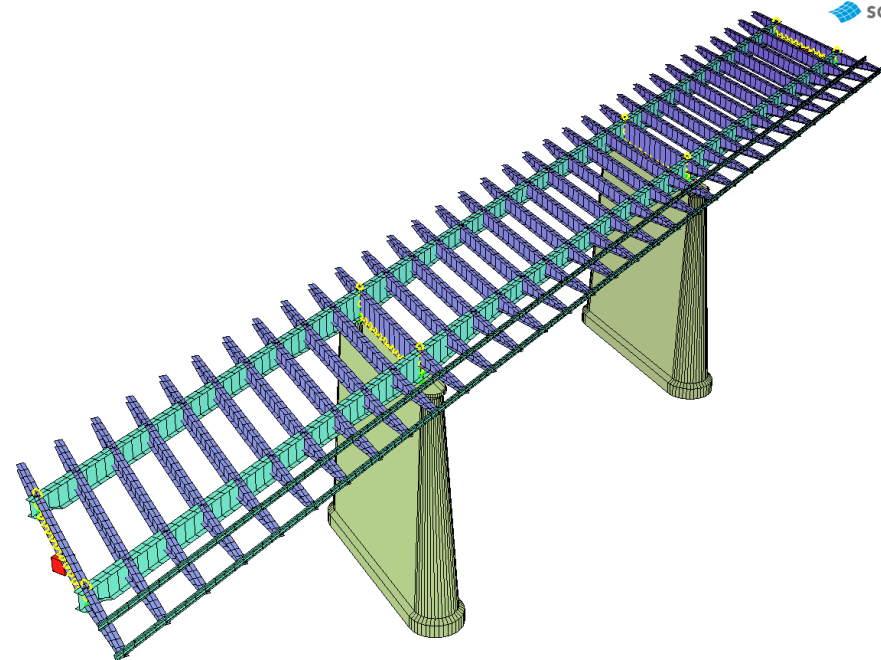
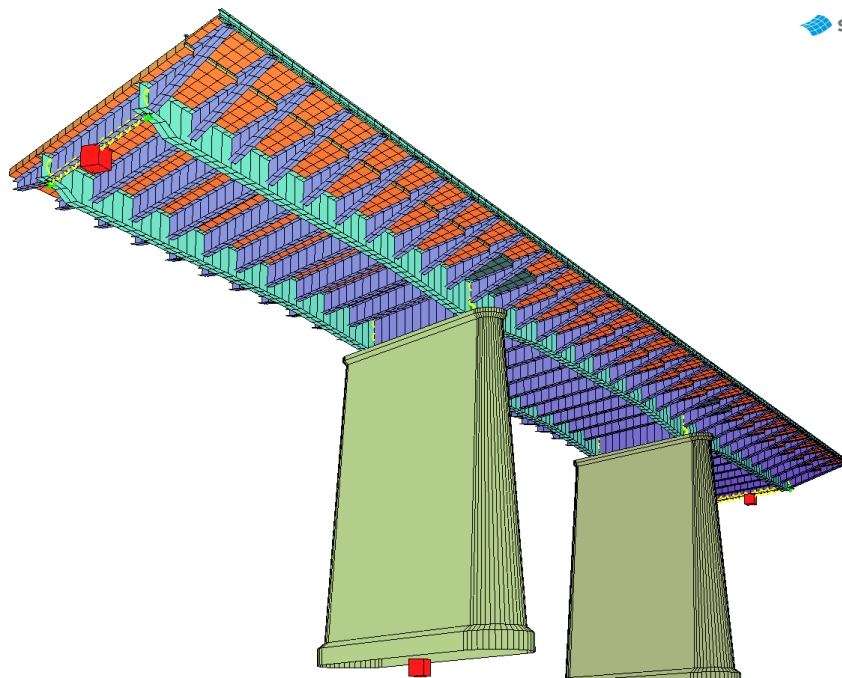

ANALISI DEL MONTAGGIO STATO DI PROGETTO



FASE 1

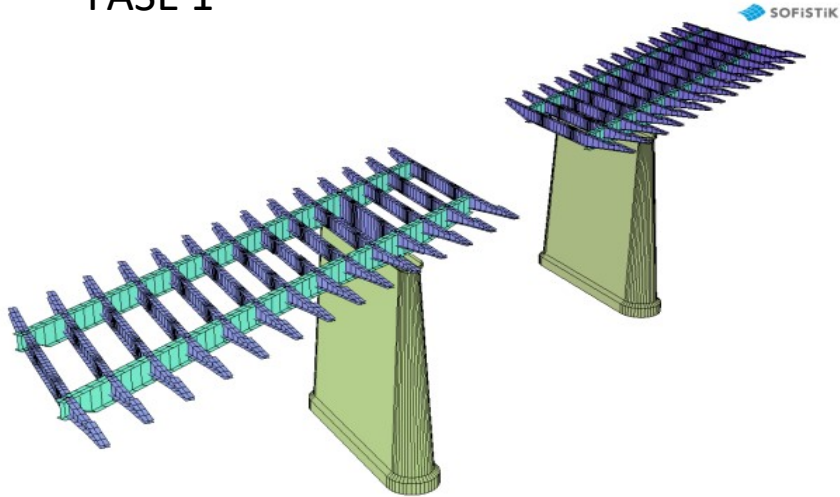

FASE 2

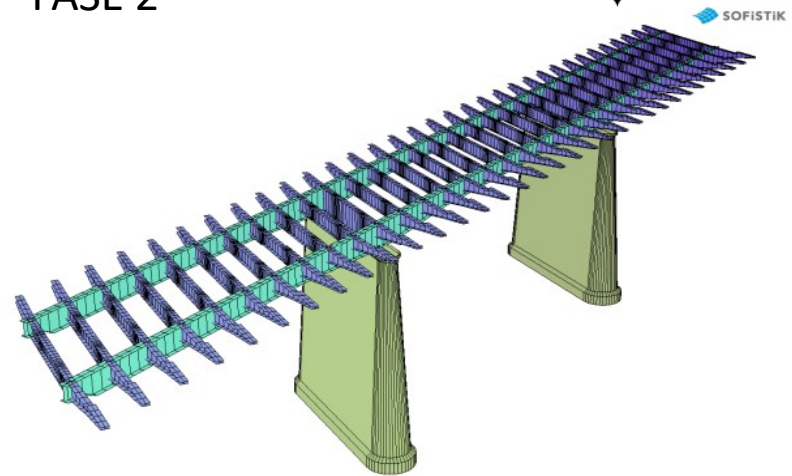

FASE 3

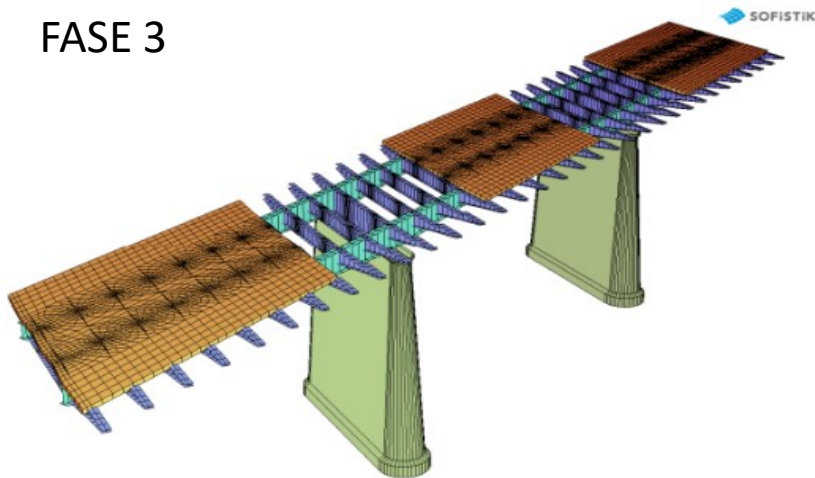

FASE 4

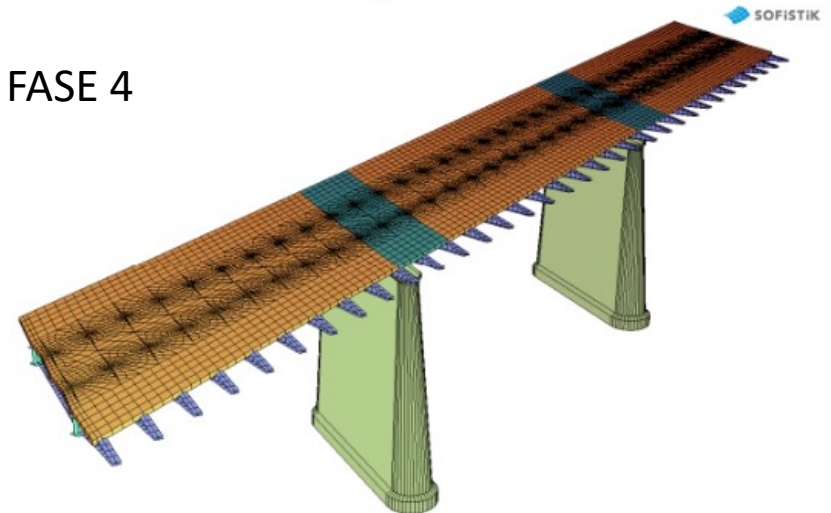



PROVINCIA
DI RAVENNA

FASI COSTRUTTIVE



PROVINCIA
DI RAVENNA

DEMOLIZIONE DELL'IMPALCATO

del ponte esistente

FASI DI DEMOLIZIONE DEL PONTE ESISTENTE

FASE 1



PROVINCIA
DI RAVENNA

Rimozione della campata centrale

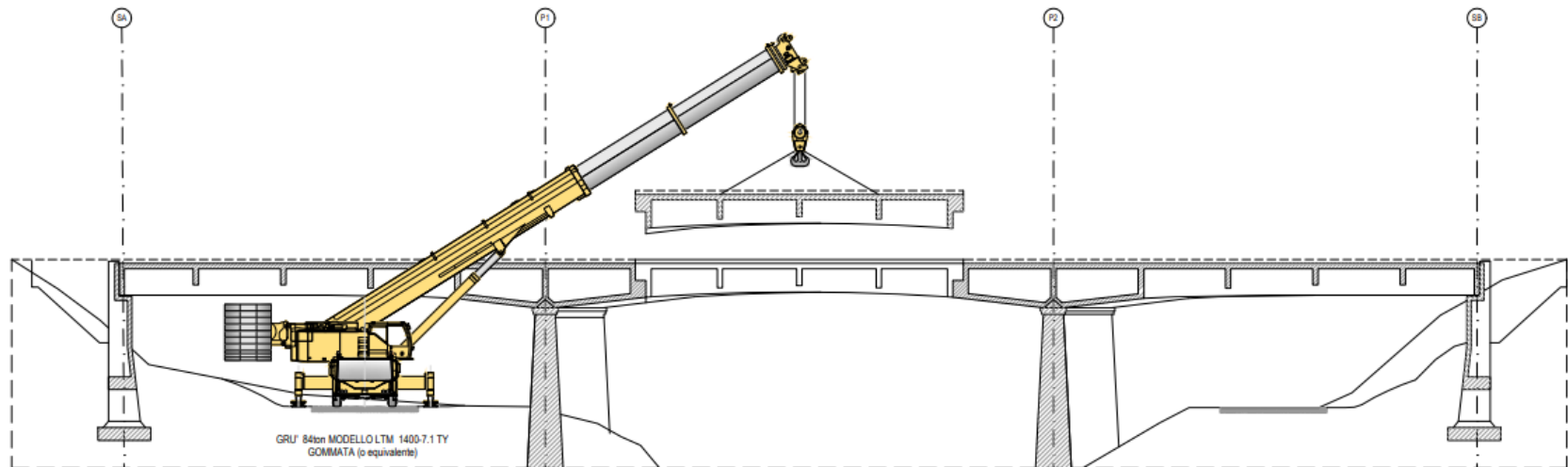

FASI DI DEMOLIZIONE DEL PONTE ESISTENTE

FASE 2



PROVINCIA
DI RAVENNA

Rimozione della campata laterale lato Ragone

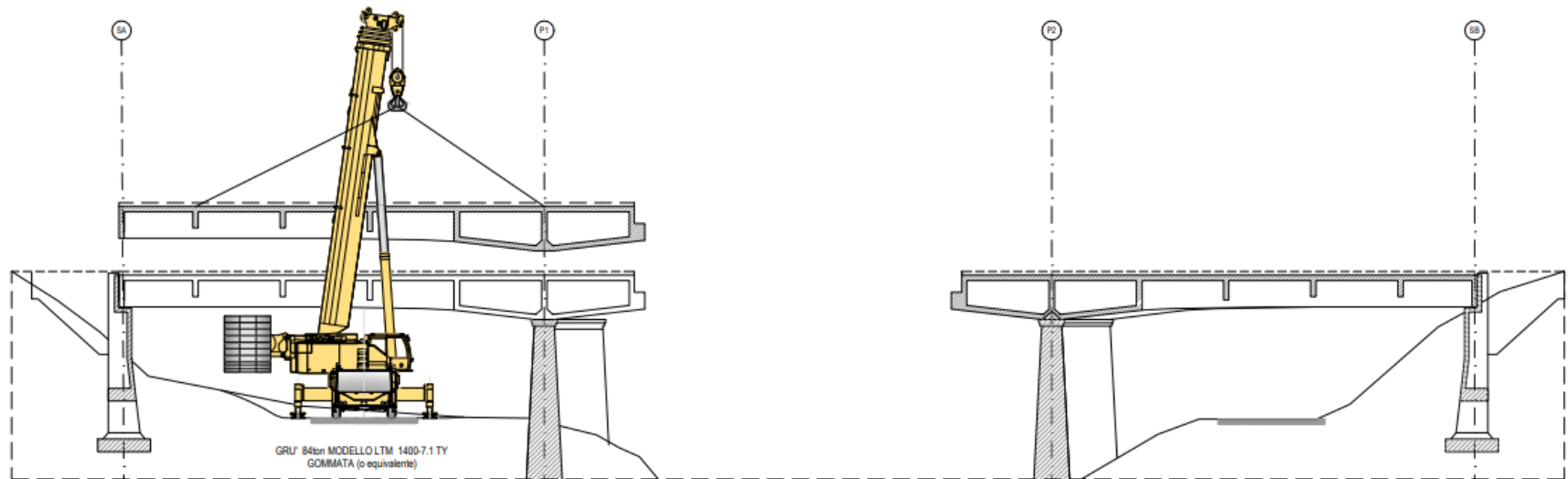

FASI DI DEMOLIZIONE DEL PONTE ESISTENTE

FASE 3



PROVINCIA
DI RAVENNA

Rimozione della campata laterale lato San Pancrazio

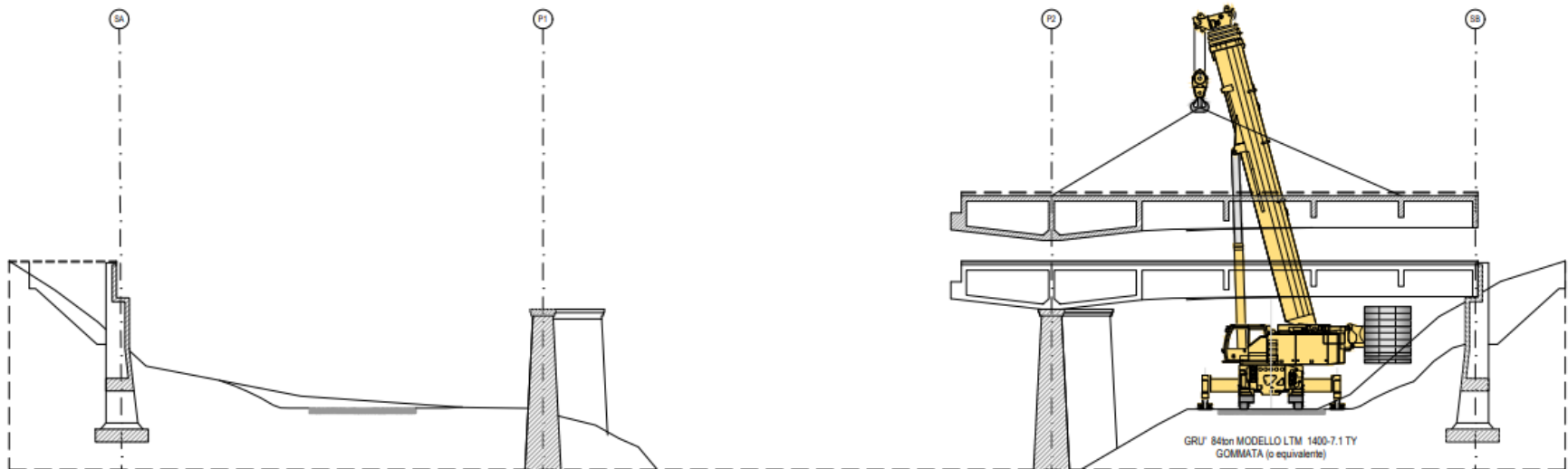



PROVINCIA
DI RAVENNA

REALIZZAZIONE DEL NUOVO IMPALCATO

FASI REALIZZATIVE

REALIZZAZIONE DEL NUOVO IMPALCATO



PROVINCIA
DI RAVENNA

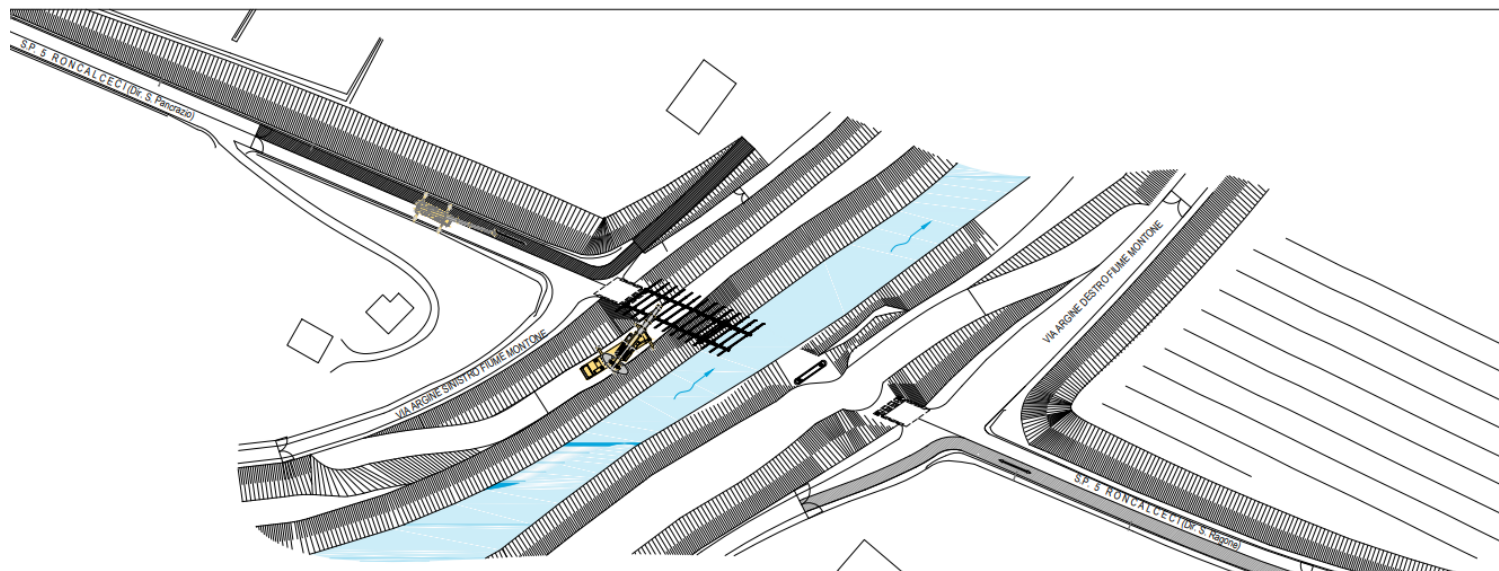
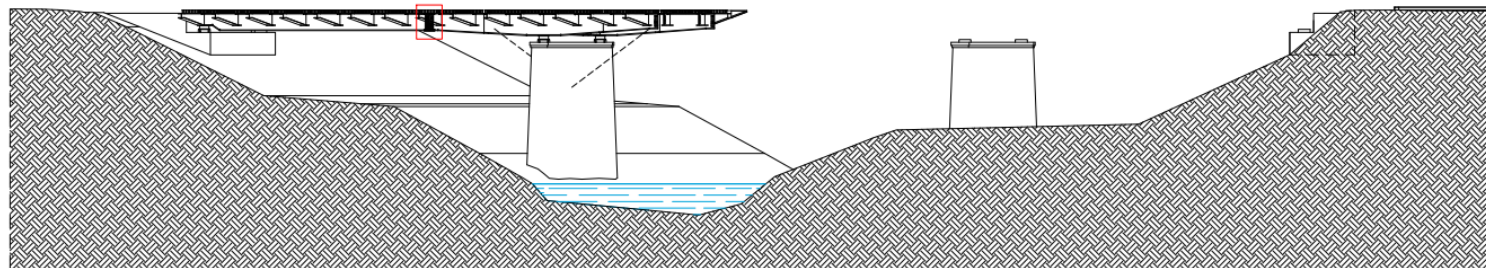

FASI REALIZZATIVE

REALIZZAZIONE DEL NUOVO IMPALCATO



PROVINCIA
DI RAVENNA

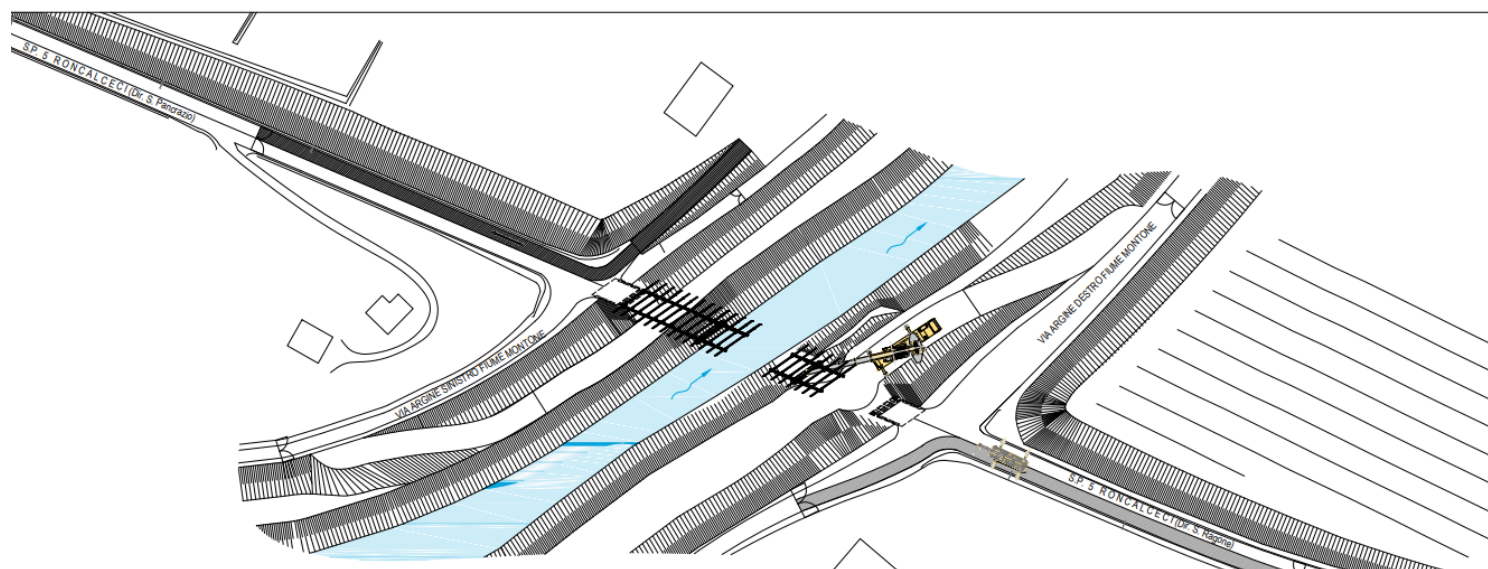
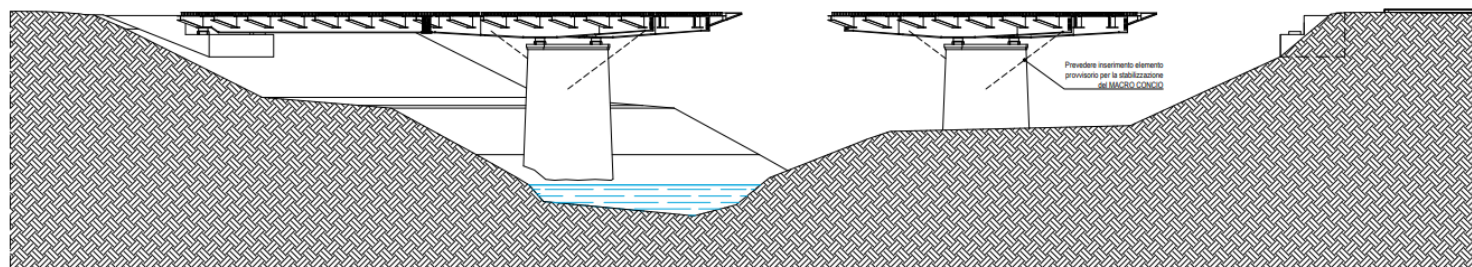

FASI REALIZZATIVE

REALIZZAZIONE DEL NUOVO IMPALCATO



PROVINCIA
DI RAVENNA

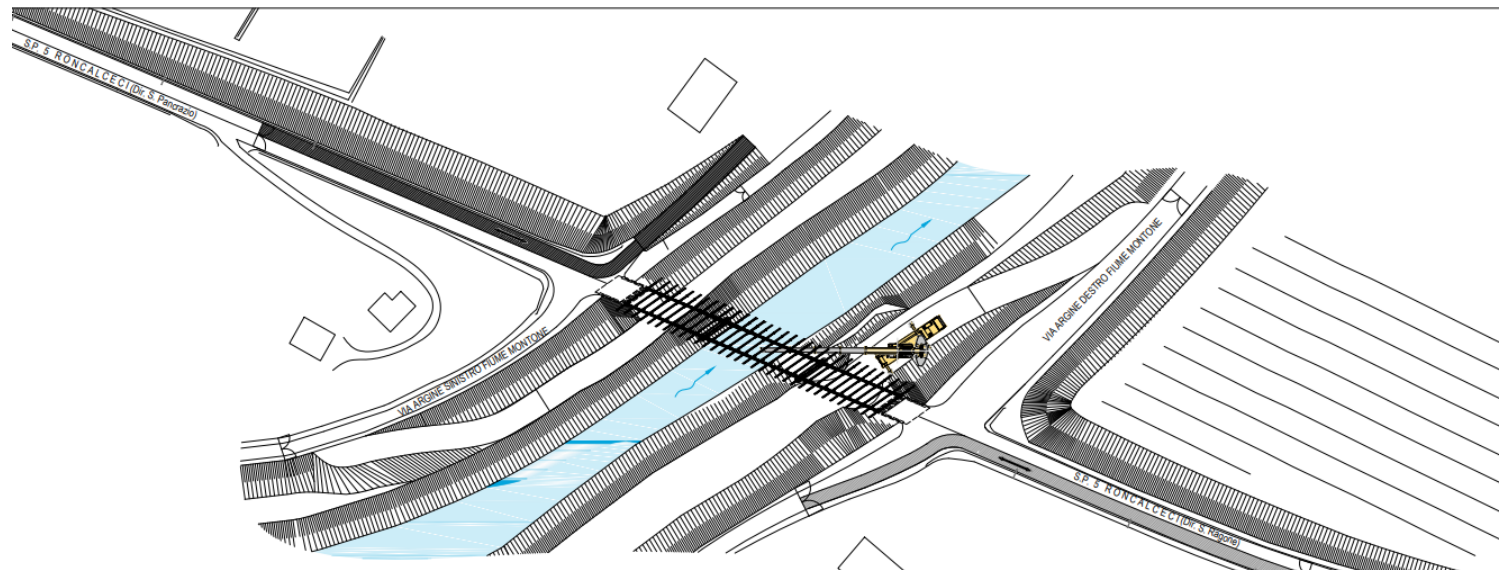
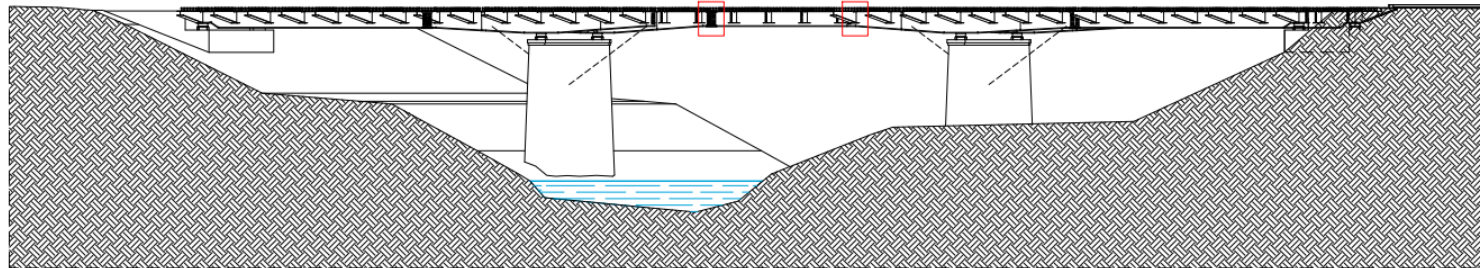



PROVINCIA
DI RAVENNA

OPERE DI PROTEZIONE IDRAULICA E FINITURE

FASI REALIZZATIVE

OPERE DI PROTEZIONE IDRAULICA



PROVINCIA
DI RAVENNA

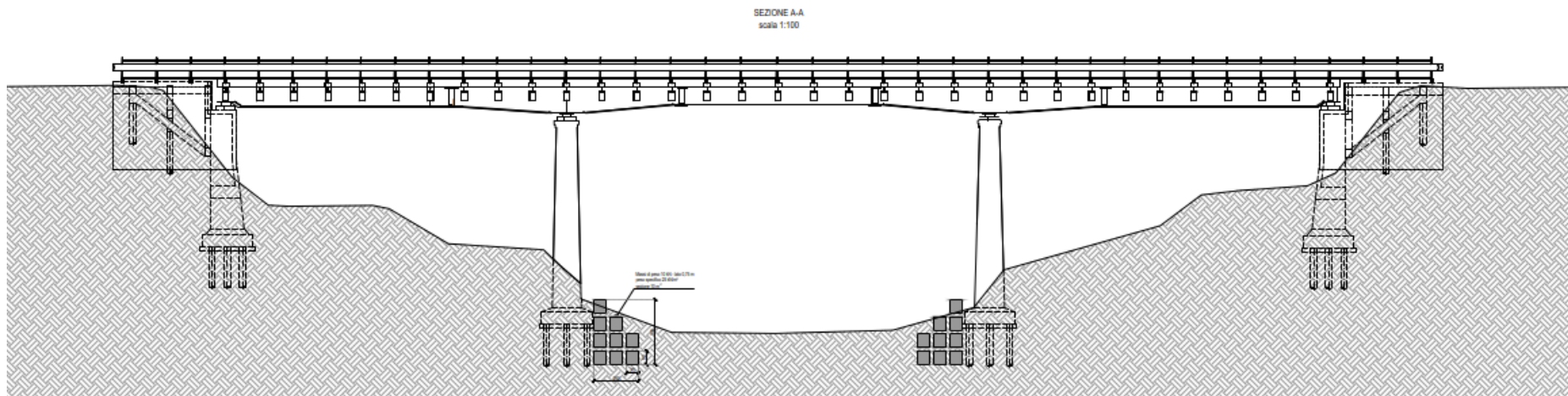
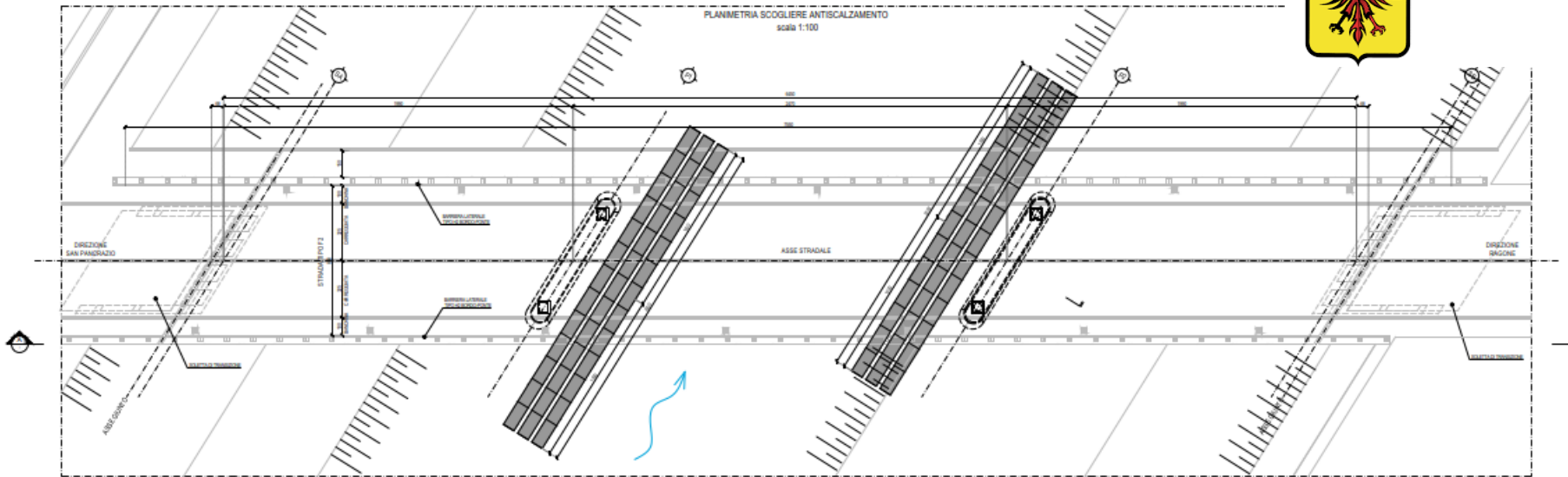



PROVINCIA
DI RAVENNA

OPERA PRELIMINARE ALL'INTERVENTO



PROVINCIA
DI RAVENNA

OPERA PRELIMINARE ALL'INTERVENTO

Realizzazione di by-pass per
alloggiamento provvisorio
reti sottoservizi

OPERE ACCESSORIE

CAVO SOSPESO PER BY-PASS SOTTOSERVIZI



PROVINCIA
DI RAVENNA





PROVINCIA
DI RAVENNA

OPERE ACCESSORIE

CAVO SOSPESO PER BY-PASS SOTTOSERVIZI

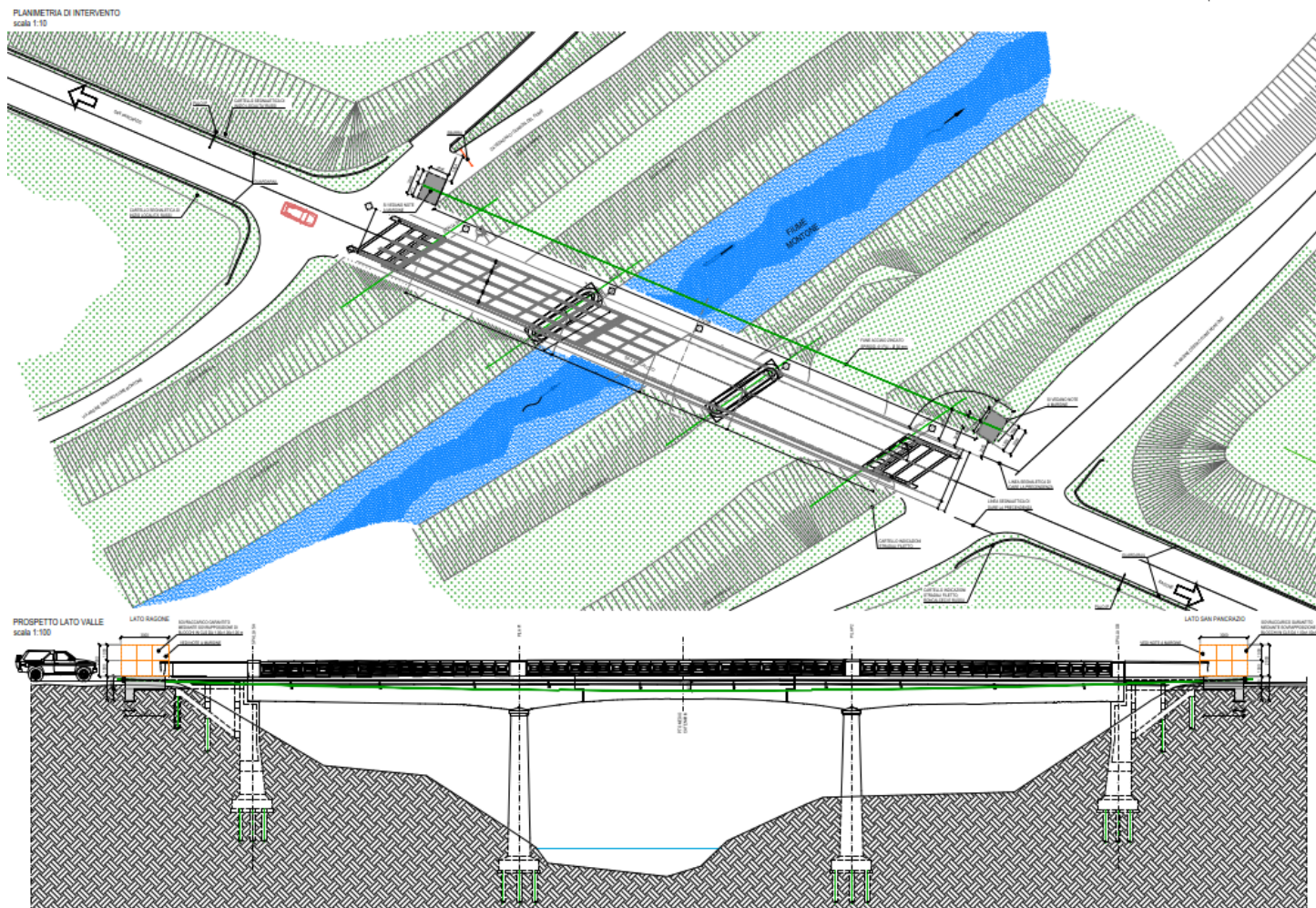

ROAD - MAP

1 - 15 AGOSTO

Avvio realizzazione OPERA PROVVISORIALE di BY-PASS sottoservizi



11 - 30 SETTEMBRE

Completamento OPERA PROVVISORIALE di BY-PASS sottoservizi

OTTOBRE 2023

Spostamento sottoservizi nell'opera provvisoriale
da parte di TELECOM e LEPIDA

NOVEMBRE 2023 – PRIMAVERA 2024

Realizzazione lavori principali di adeguamento del ponte

ROAD - MAP



PUNTI CRITICI

- Ritardi negli interventi di TELECOM e LEPIDA
 - Stagione AUTUNNALE / INVERNALE
- Lavorazioni aggiuntive eventualmente richieste durante l'esecuzione dei lavori da parte dell'Ente gestore del fiume (Regione E-R)

PUNTI DI FORZA DELLA ROAD-MAP

- Ponte di Prada ricostruito
- Stagione agricola conclusa
- Nuovo impalcato metallico pronto da montare

ROAD - MAP

PREMONTAGGIO IN OFFICINA





PROVINCIA
DI RAVENNA

ROAD - MAP

PREMONTAGGIO IN OFFICINA

